

ECOFLOW

Portable Power Station
Grounding Adapter | User Manual

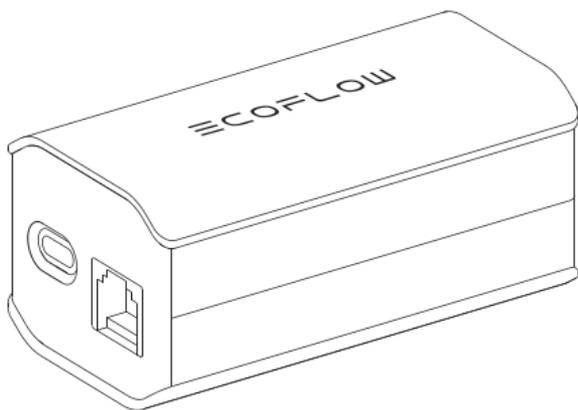

Contents

en English	P01 – P05
jp 日本語	P06 – P10
cn 简体中文	P11 – P14
de Deutsch	P15 – P18
fr Français	P19 – P22
it Italiano	P23 – P26
sp Español	P27 – P30
nl Nederlands	P31 – P34
ru Русский	P35 – P38
tc 繁體中文	P39 – P42

Product Introduction

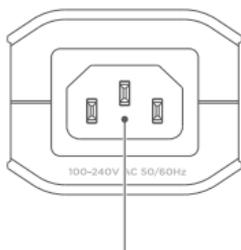

AC input port

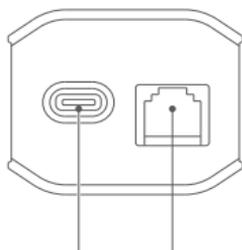

USB-C output port

Communication Port

Product Specifications

AC input voltage:	100-240 V-50/60 Hz
USB-C supply voltage:	5 V \equiv 300 mA Max
Network port supply voltage:	12 V \equiv 300 mA Max
Operating temperature:	-10-45°C (14-113°F)

User Instructions

1. This product is only suitable for use with the EcoFlow DELTA Pro and DELTA Max.
2. To ensure safety while charging an electric vehicle, the AC charging function of the machine will be disabled after successful identification of the Portable Power Station Grounding Adapter and the machine.
3. The USB-C to USB-C cable is a custom cable and not compatible with other universal Type C cables. This cable must be properly kept. Replacements can be purchased from the official sales channels of EcoFlow if needed.
4. Please ensure that this product is discarded in accordance with environmental protection guidelines. When it reaches the end of its service life, it must be discarded in a designated recycling point for electronic and electrical products.

How to Use It

I. Connecting the DELTA Pro

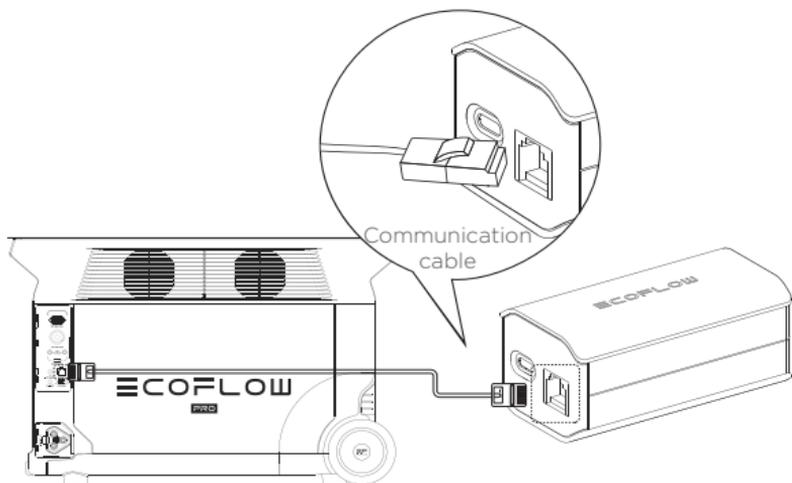

* Communication Port: For use with DELTA Pro only

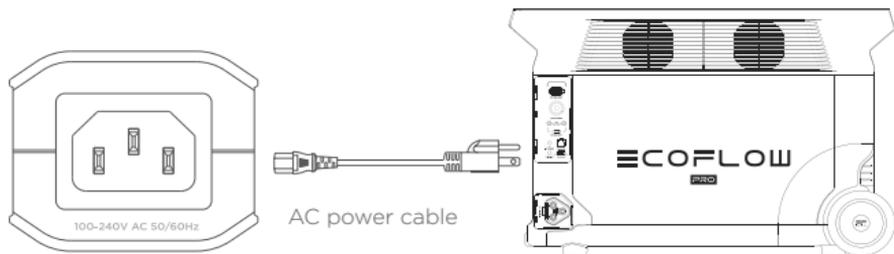

* We recommend using the DELTA Pro power cable. This is supplied as standard or can be purchased separately.

How to Use It

II. Connecting the Double Voltage Hub

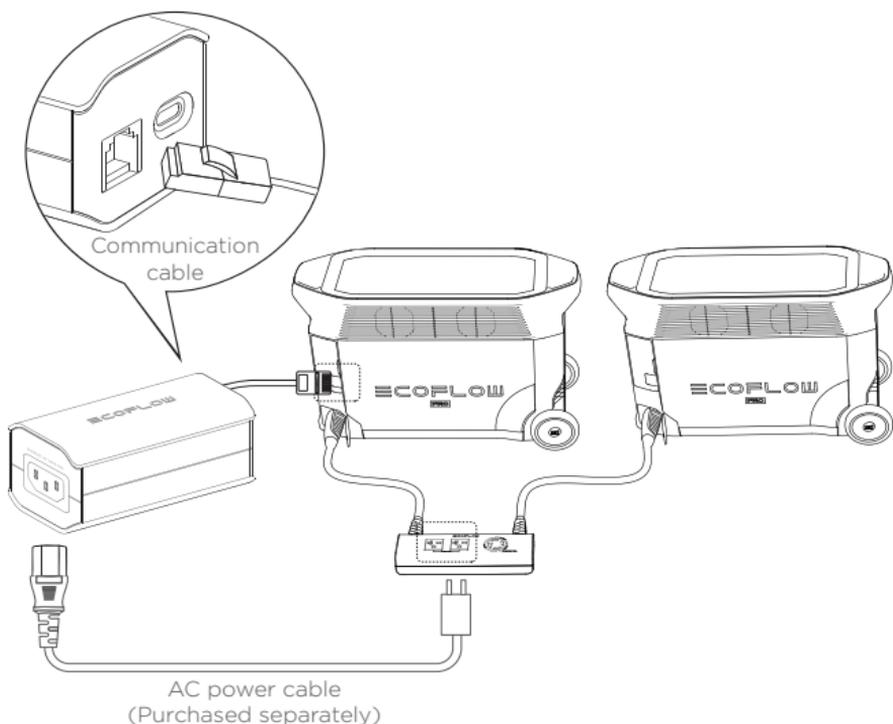

1. If you need to use a dual current hub to charge your electric vehicle, you will need to purchase a separate NEMA 6-15P to C13 or NEMA 6-20P to C13 power cable.
2. The Portable Power Station Grounding Adapter can be connected to any of the DELTA Pro network ports.

How to Use It

III. Connecting the DELTA Max

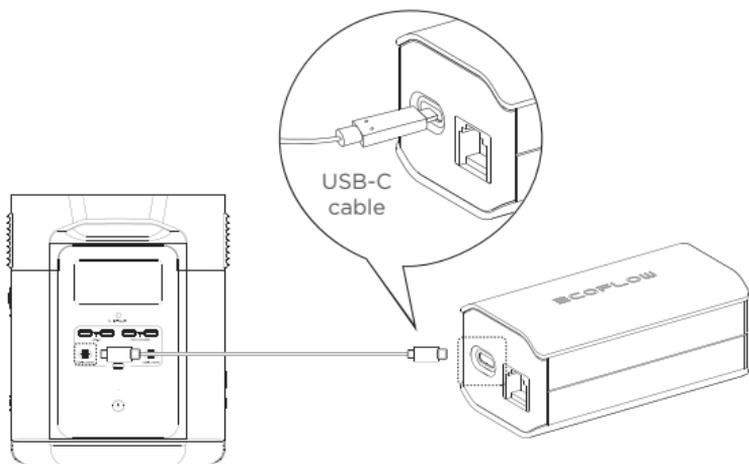

(Please plug into the left USB-C port; do not use the right USB-C port)

* USB-C port: For use with DELTA Max only

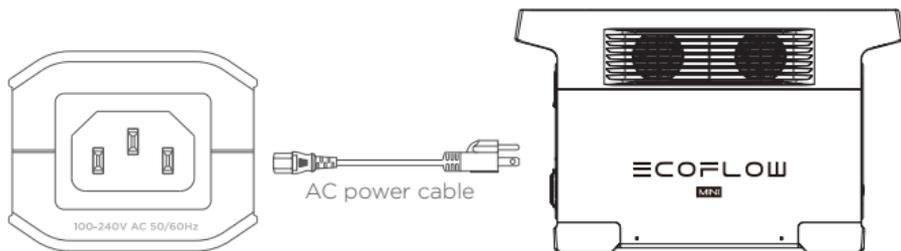

* We recommend using the DELTA Max power cable. This is supplied as standard or can be purchased separately.

Register Now to Get 24-MONTH WARRANTY!



<https://warranty.ecoflow.com/>



Why register?

- Serve as proof for an insurance loss claim
- Get instant EcoFlow product support
- Get instant access to product release news

Contact us

+1 (800)-368-8604 Mon-Fri 9 am-9 pm (EST)

<https://ecoflow.com/pages/contact-us>



NA/LA/APAC/MEA: support@ecoflow.com,

EU: support.eu@ecoflow.com, **AU:** support.au@ecoflow.com

Social media:



@ecoflowtech

製品紹介

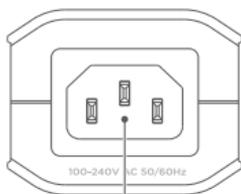

AC入力ポート

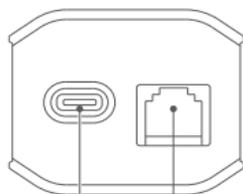

USB-C出力ポート 通信ポート

製品仕様

AC入力電圧: 100-240V~ 50/60Hz

USB-C供給電圧: 5V ≡ 300mA 最大

通信ポート供給電圧: 12V ≡ 300mA 最大

動作温度: -10 ~ 45°C

ユーザーインストラクション

- 1.本製品はEcoFlow DELTA ProおよびEcoFlow DELTA Maxとの使用にのみ適しています。
- 2.電気自動車の充電中は安全のため、本製品とEcoFlow ポータブル電源の識別に成功すると、ポータブル電源にAC充電できなくなります。
- 3.同梱のUSB-C to USB-Cケーブルが専用ケーブルで、他の汎用USB-Cケーブルとは互換性がないため、大切に保管してください。紛失の場合はEcoFlow公式サイトにお問い合わせください。
- 4.本製品を廃棄する際にお住まいの自治体の条例や法規制に従って廃棄してください。

使用方法

I. EcoFlow DELTA Proとの接続方法

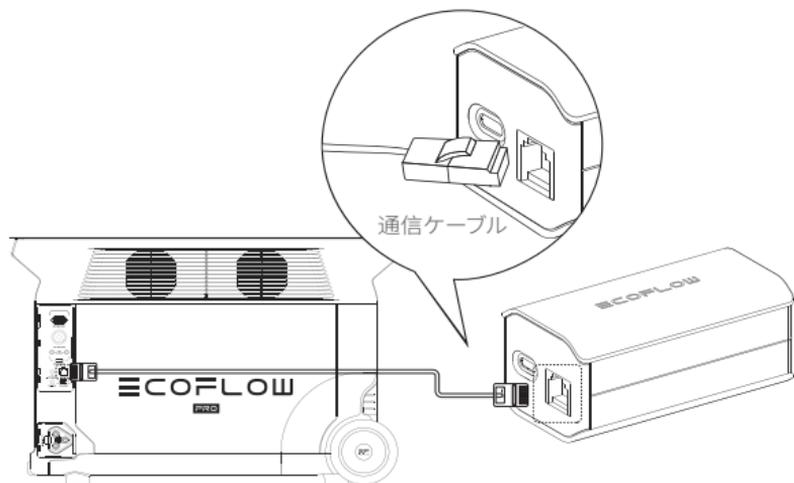

*通信ポート: EcoFlow DELTA Proのみに適用する。

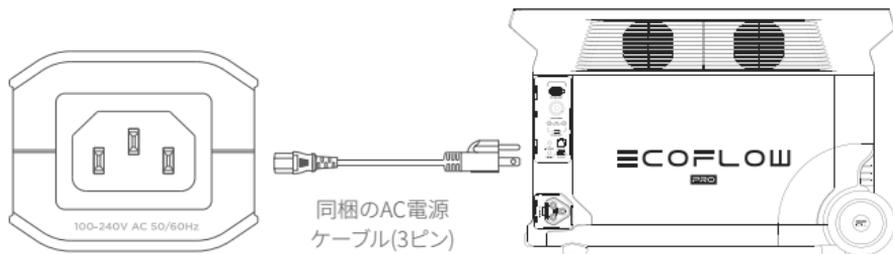

*本製品に同梱するAC電源ケーブル(3ピン)をご利用ください。

使用方法

II. Double Voltage ハブの接続

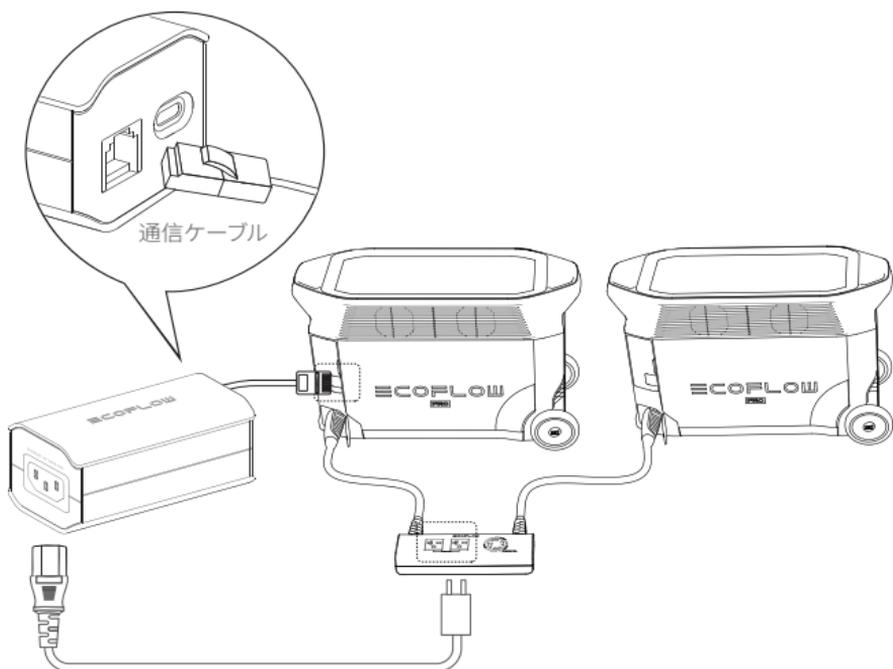

「NEMA 6-15P to C13」 or 「NEMA 6-20P to C13」

電源ケーブル(別途購入)

1. Double Voltage ハブを使用して電気自動車を充電する場合は別途「NEMA6-15P to C13」または「NEMA 6-20P to C13」電源ケーブルを購入する必要があります。
2. 上図のように本製品を別途購入の電源ケーブルをDouble Voltage ハブに接続し、通信ケーブルを任意のEcoFlow DELTA Proの通信ポートに接続してください。

使用方法

III. EcoFlow DELTA Maxとの接続方法

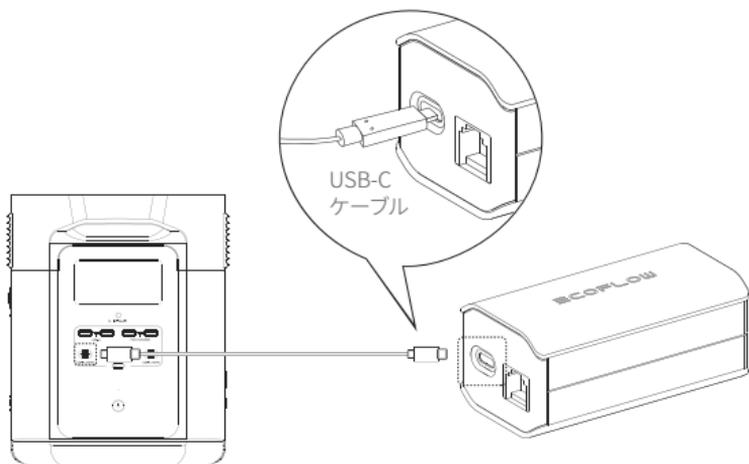

(左側のUSB-Cポートに接続してください。
右側のUSB-Cポートは使用しないでください)

*USB-Cポート: EcoFlow DELTA Maxのみに適用する。

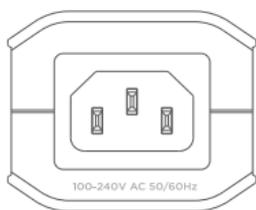

同梱のAC電源
ケーブル(3ピン)

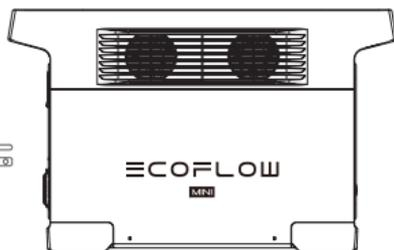

*本製品に同梱するAC電源ケーブル(3ピン)をご利用ください。

いますぐ
24カ月保証に登録しましょう!



<https://warranty.ecoflow.com/>



登録のメリットは？

- メーカー保証の証明として使用できます
- EcoFlow製品のサポートをスムーズに利用できます

ご連絡先

☎ +81 050-3138-8158 10:00~12:00、13:00~17:00 (JST)

(土曜・日曜・祝日、年末年始を除く)

🌐 <https://jp.ecoflow.com/pages/contactus>



日本語のみ support.jp@ecoflow.com

英語のみ support@ecoflow.com

ソーシャルメディア:    @ecoflowjapan

产品介绍

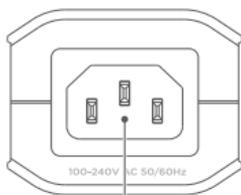

AC输入端口

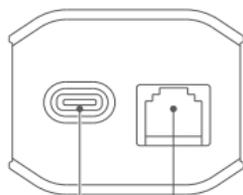

USB-C输出口 网口

产品参数

AC输入电压:	100-240V~ 50/60Hz
USB-C供电电压:	5V $\overline{\text{---}}$ 300mA Max
网口供电电压:	12V $\overline{\text{---}}$ 300mA Max
工作环境温度:	-10 ~ 45°C(14~113°F)

使用须知

1. 本产品仅适用于EcoFlow产品:DLETA Pro和DLETA Max。
2. 为保证电动车充电过程中的用电安全,免接地插座和主机识别成功后,主机的交流充电功能会被禁用。
3. USB-C to USB-C线是定制线,与其他通用Type C数据线不兼容,请保存完好,若有需求请于EcoFlow官方渠道购买。
4. 请保证本产品的丢弃符合保护环境原则,到期后必须放到符合电子与电气产品循环回收指定的回收点。

使用方法

一、连接DELTA Pro

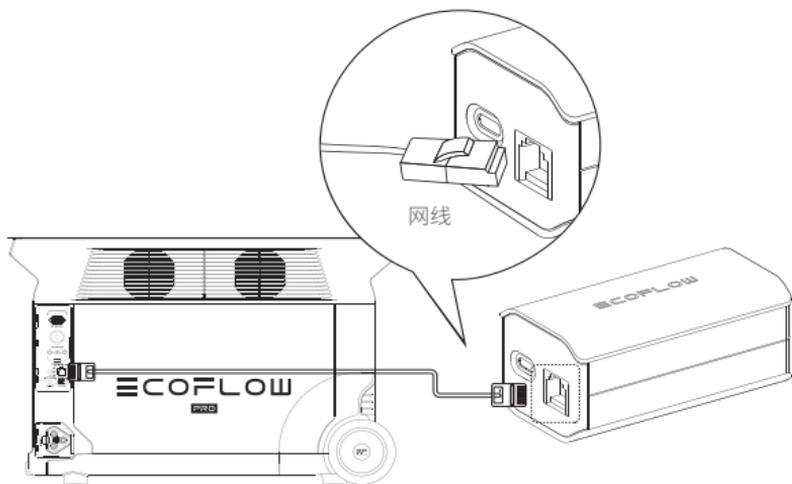

*网口:仅适用于DELTA PRO

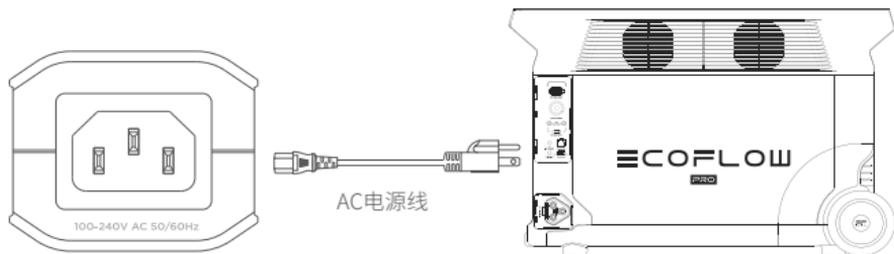

*建议使用DELTA PRO标配的电源线,也可以单独购买

使用方法

二、连接DELTA Max

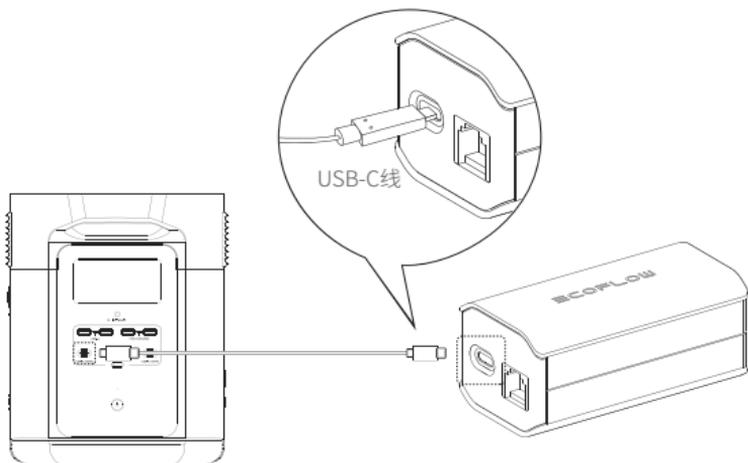

(请接入左侧C口, 接右侧C口无效)

*USB-C口: 仅适用于DELTA MAX

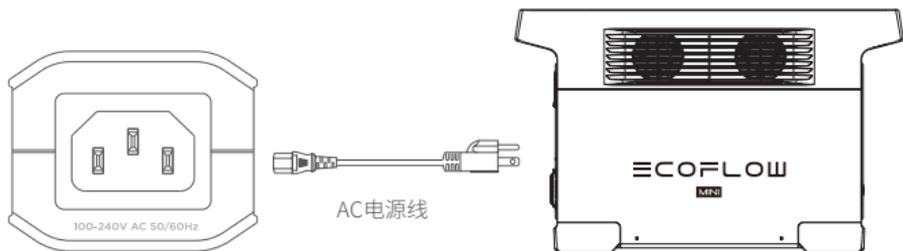

*建议使用DELTA Max标配的电源线, 也可以单独购买

立即申请 24 个月保修计划!



<https://warranty.ecoflow.com/>



申请理由

- 申请保险索偿证明
- 获得 EcoFlow 支援服务
- 获得最新产品咨询

联系我们

+1 (800)-368-8604 星期一至五, 9am-9pm (EST)

<https://ecoflow.com/pages/contact-us>



北美/拉美/亚太/中东非: support@ecoflow.com,
欧洲: support.eu@ecoflow.com, 澳洲: support.au@ecoflow.com

社交媒体:



[@ecoflowtech](https://twitter.com/ecoflowtech)

Produktvorstellung

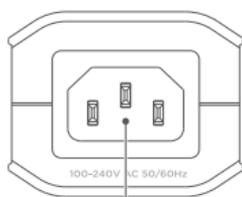

AC-Eingang

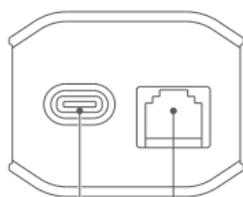

USB-C-Ausgang

Kommunikationsanschluss

Produktspezifikationen

AC-Eingangsspannung:	100-240 V-50/60 Hz
USB-C-Versorgungsspannung:	5 V \equiv max.300 mA
Versorgungsspannung an der Netzwerkschnittstelle:	12 V \equiv max.300 mA
Betriebstemperatur:	-10-45°C (14-113°F)

Benutzeranweisungen

1. Dieses Produkt ist nur für den Einsatz mit EcoFlow DELTA Pro und DELTA Max geeignet.
2. Um die Sicherheit beim Laden eines Elektrofahrzeugs zu gewährleisten, wird die AC-Ladefunktion des Geräts nach erfolgreicher Identifizierung des Erdungsadapters für tragbare Powerstations und des Geräts deaktiviert.
3. Das USB-C-zu-USB-C-Kabel ist ein produktspezifisches Kabel und nicht mit anderen Universalkabeln vom Typ USB-C kompatibel. Dieses Kabel muss ordnungsgemäß aufbewahrt werden. Ersatzprodukte können bei Bedarf über die offiziellen Vertriebskanäle von EcoFlow erworben werden.
4. Stellen Sie sicher, dass die Entsorgung dieses Produkts gemäß den Umweltschutzrichtlinien erfolgt. Wenn das Produkt das Ende seiner Lebensdauer erreicht hat, muss es bei einer dafür vorgesehenen Recyclingstelle für elektronische und elektrische Produkte entsorgt werden.

Verwendung

I. Anschließen der DELTA Pro

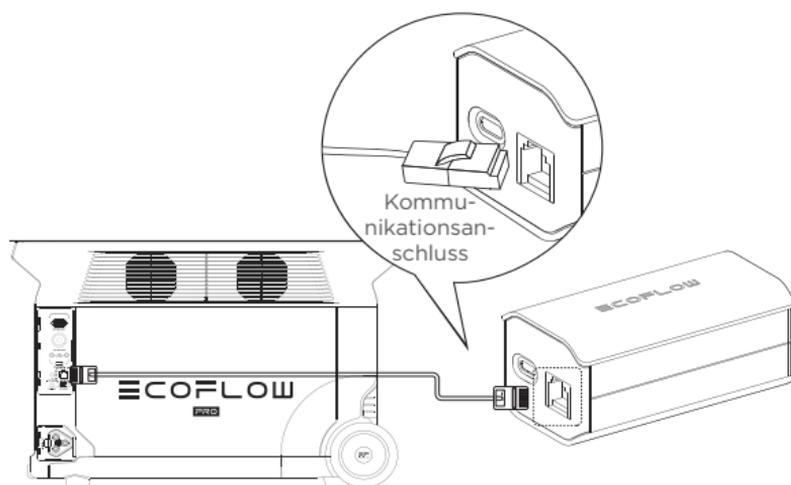

.....* Kommunikationsanschluss: Nur zur Verwendung mit DELTA Pro

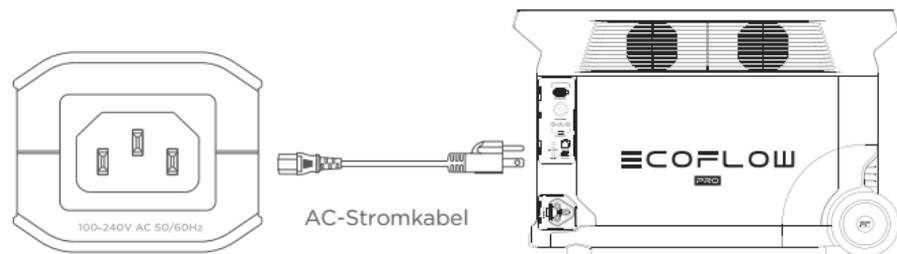

* Wir empfehlen die Verwendung des DELTA Pro-Stromkabels. Dieses ist standardmäßig im Lieferumfang enthalten oder kann separat erworben werden.

Verwendung

II. Anschließen der DELTA Max

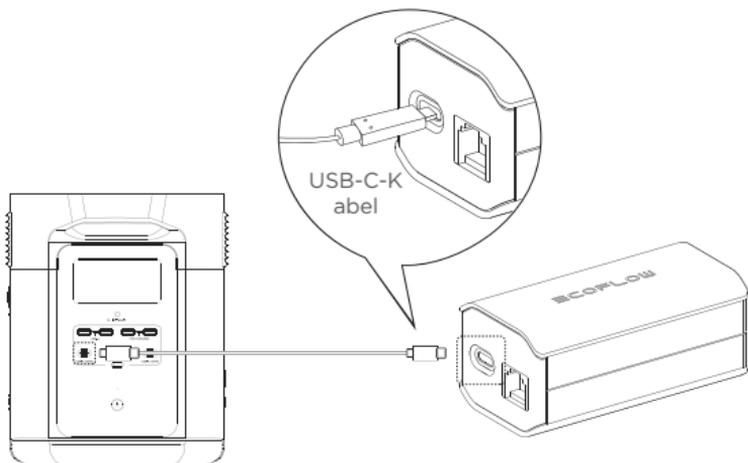

(Bitte an den linken USB-C-Anschluss anschließen; nicht den rechten USB-C-Anschluss benutzen)

* USB-C-Anschluss: Nur zur Verwendung mit DELTA Max

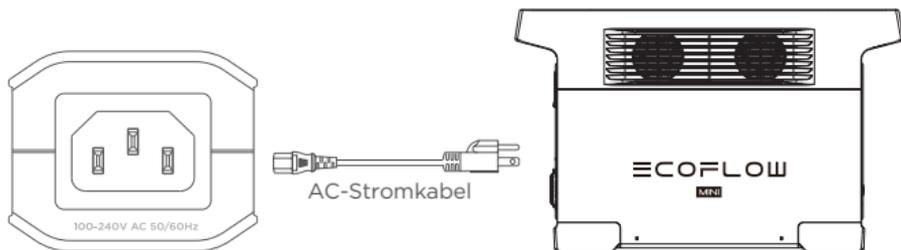

* Wir empfehlen die Verwendung des DELTA Max-Stromkabels. Dieses ist standardmäßig im Lieferumfang enthalten oder kann separat erworben werden.

Registrieren Sie ihr Produkt für eine **24-MONATIGE GARANTIE!**



<https://warranty.ecoflow.com/>



Warum registrieren?

- Nachweis für die Versicherung im Verlustfall
- Schneller Produktsupport durch EcoFlow
- Zugang zu Produktneuigkeiten

Kontakt

 +1 (800)-368-8604 Mo-Fr 9:00 Uhr bis 21:00 Uhr (EST)

 <https://ecoflow.com/pages/contact-us>



NA/LA/APAC/MEA: support@ecoflow.com,

EU: support.eu@ecoflow.com, AU: support.au@ecoflow.com

Soziale Medien:



[@ecoflowtech](https://twitter.com/ecoflowtech)

Présentation du produit

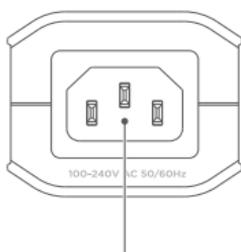

Port d'entrée CA

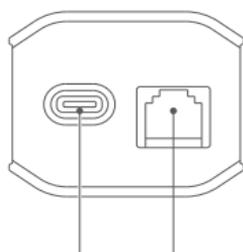

Port de sortie USB-C Port de communication

Caractéristiques du produit

Tension d'entrée CA:	100-240 V-50/60 Hz
Tension d'alimentation USB-C:	5 V $\overline{\text{---}}$ 300 mA max
Tension d'alimentation du port réseau:	12 V $\overline{\text{---}}$ 300 mA max
Température de fonctionnement:	-10-45°C

Instructions d'utilisation

1. Ce produit est uniquement adapté à une utilisation avec les stations EcoFlow DELTA Pro et DELTA Max.
2. Pour garantir la sécurité lors de la recharge d'un véhicule électrique, la fonction de charge CA de la machine est désactivée après l'identification réussie de l'adaptateur de mise à la terre de la station électrique portable et de la machine.
3. Le câble USB-C vers USB-C est un câble personnalisé et n'est pas compatible avec d'autres câbles universels de type C. Ce câble doit être correctement conservé. Des pièces de rechange peuvent être achetées auprès des canaux de vente officiels d'EcoFlow si nécessaire.
4. Veuillez vous assurer que ce produit est mis au rebut conformément aux directives de protection de l'environnement. Lorsque le produit atteint la fin de sa durée de vie, il doit être mis au rebut à un point de recyclage dédié aux produits électroniques et électriques.

Comment utiliser le produit

I. Connexion de la DELTA Pro

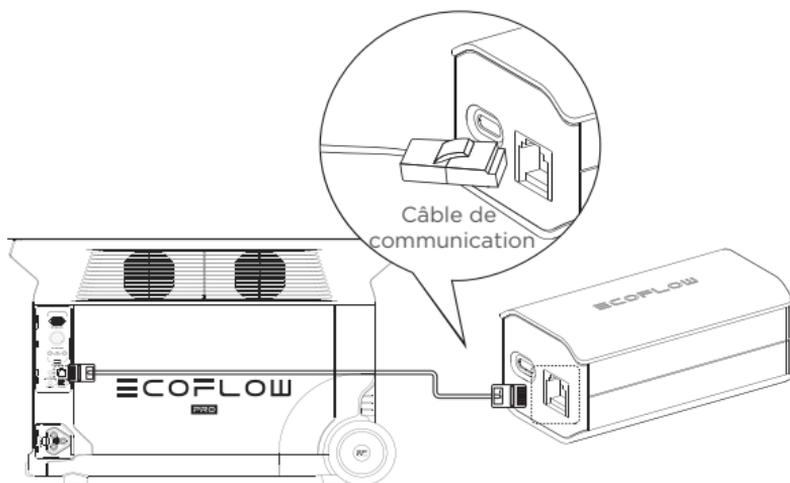

* Port de communication : À utiliser uniquement avec la DELTA Pro

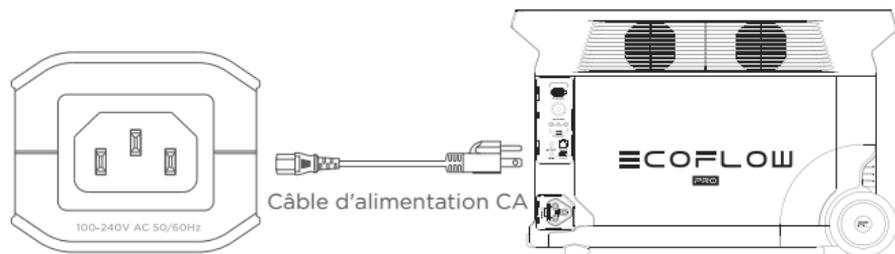

* Nous vous recommandons d'utiliser le câble d'alimentation DELTA Pro. Celui-ci est fourni de série ou peut être acheté séparément.

Comment utiliser le produit

II. Connexion de la DELTA Max

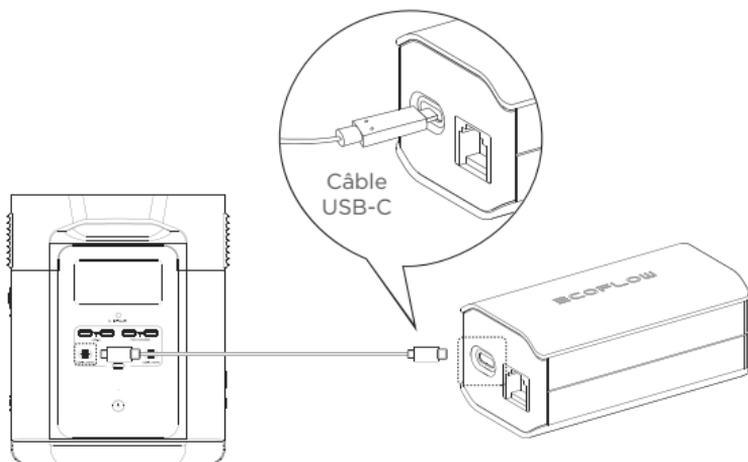

(Branchez-le sur le port USB-C gauche ; n'utilisez pas le port USB-C droit)

* Port USB-C : À utiliser uniquement avec la DELTA Max

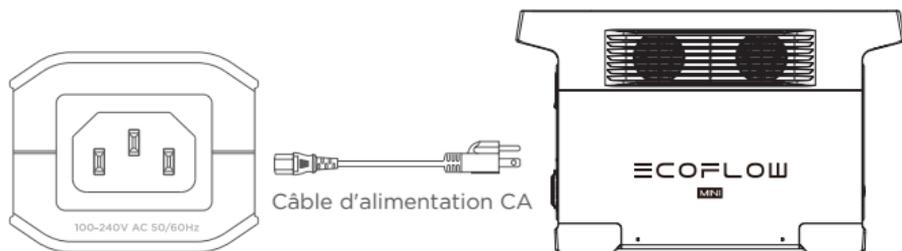

* Nous vous recommandons d'utiliser le câble d'alimentation DELTA Max. Celui-ci est fourni de série ou peut être acheté séparément.

Inscrivez-vous dès maintenant
pour obtenir une
GARANTIE DE 24 MOIS !



<https://warranty.ecoflow.com/>



Pourquoi s'inscrire ?

- Sert de preuve pour une réclamation d'assurance en cas de perte
- Bénéficiez d'une assistance produit Ecoflow immédiate
- Bénéficiez d'un accès instantané aux actualités sur les nouveaux produits

Contactez-nous

☎ +1 (800)-368-8604 de lundi à vendredi de 9 h à 21 h (EST)

🌐 <https://ecoflow.com/pages/contact-us>



NA/LA/APAC/MEA: support@ecoflow.com,

EU: support.eu@ecoflow.com, AU: support.au@ecoflow.com

Réseaux sociaux :



[@ecoflowtech](https://www.ecoflowtech.com)

Introduzione ai prodotti

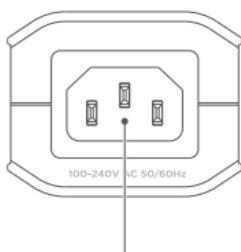

Porta di ingresso CA

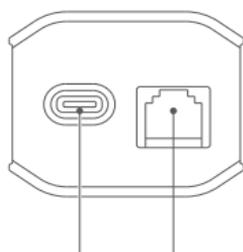

Porta di uscita USB-C Porta di comunicazione

Specifiche del prodotto

Tensione di ingresso CA:	100-240 V-50/60 Hz
Tensione di alimentazione USB-C:	5 V \equiv 300 mA max
Tensione di alimentazione porta di rete:	12 V \equiv 300 mA max
Temperatura di esercizio:	-10-45°C (14-113°F)

Istruzioni per l'utente

1. Questo prodotto è adatto solo per l'uso con Ecoflow DELTA Pro e DELTA Max.
2. Per garantire la sicurezza durante la ricarica di un veicolo elettrico, la funzione di carica CA della macchina viene disattivata dopo l'identificazione corretta dell'adattatore di messa a terra della centrale elettrica portatile e della macchina.
3. Il cavo da USB-C a USB-C è un cavo personalizzato e non è compatibile con altri cavi universali di tipo C. Questo cavo deve essere conservato correttamente. Gli elementi di sostituzione possono essere acquistati presso i canali di vendita ufficiali di Ecoflow, se necessario.
4. Assicurarsi che il prodotto venga smaltito in conformità alle linee guida sulla protezione ambientale. Quando raggiunge la fine della sua vita utile, deve essere smaltito in un apposito punto di riciclaggio per i prodotti elettronici ed elettrici.

Modalità di utilizzo

I. Collegamento con DELTA Pro

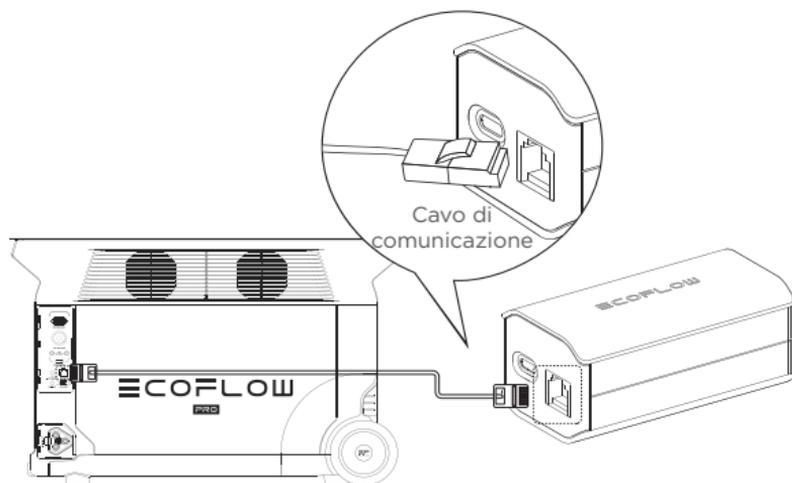

* Porta di comunicazione: Per l'uso esclusivo con DELTA Pro



* Si consiglia di utilizzare il cavo di alimentazione DELTA Pro. Questo cavo è fornito di serie o può essere acquistato separatamente

Modalità di utilizzo

II. Collegamento con DELTA Max

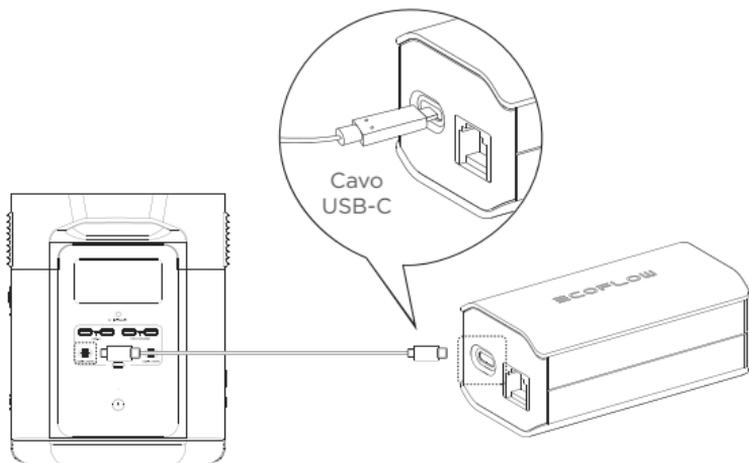

Cavo
USB-C

(Collegare alla porta USB-C sinistra;
non utilizzare la porta USB-C destra)

* Porta USB-C: Per l'uso esclusivo con DELTA Max

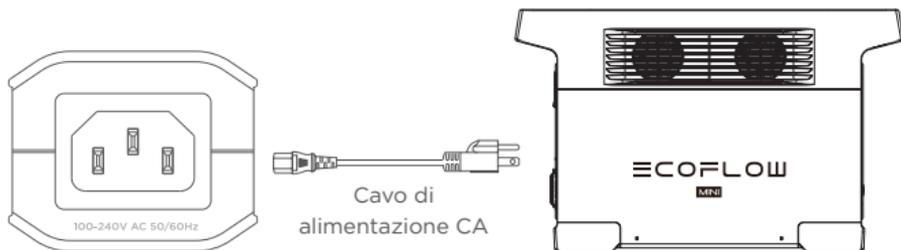

Cavo di
alimentazione CA

*Si consiglia di utilizzare il cavo di alimentazione di DELTA Max.
Fornito di serie o acquistabile separatamente.

Registrati ora per avere 24 MESI DI GARANZIA!



<https://warranty.ecoflow.com/>



Perché registrarsi?

- Serve come prova in caso di richiesta d'indennizzo
- ottieni supporto immediato per i prodotti Ecoflow
- ottieni accesso immediato alle notizie sul lancio dei prodotti

Contattaci

+1 (800)-368-8604 Lun-Ven 9-21 (EST)

<https://ecoflow.com/pages/contact-us>



NA/LA/APAC/MEA: support@ecoflow.com,

EU: support.eu@ecoflow.com, AU: support.au@ecoflow.com

Social media:



[@ecoflowtech](https://www.ecoflowtech.com)

Presentación del producto

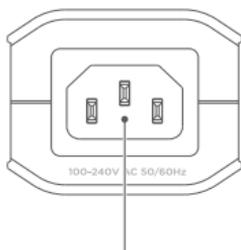

Puerto de entrada de CA

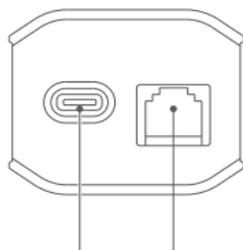

Puerto de salida
USB-C

Puerto de
comunicación

Especificaciones del producto

Tensión de entrada de CA:	100-240 V-50/60 Hz
Tensión de alimentación de USB-C:	5 V $\overline{\text{~}}$ 300 mA máx
Tensión de alimentación del puerto de red:	12 V $\overline{\text{~}}$ 300 mA máx
Temperatura de funcionamiento:	-10-45°C

Instrucciones de uso

1. Este producto solo es adecuado para su uso con el EcoFlow DELTA Pro y DELTA Max.
2. Para garantizar la seguridad durante la carga de un vehículo eléctrico, la función de carga de CA de la máquina se desactivará después de identificar correctamente el adaptador de conexión a tierra del generador de energía portátil y la máquina.
3. El cable USB-C a USB-C es un cable especial y no es compatible con otros cables universales de tipo C. Este cable debe conservarse adecuadamente. Si es necesario, se pueden adquirir recambios a través de los canales de venta oficiales de EcoFlow.
4. Asegúrese de desechar este producto de acuerdo con las directrices de protección medioambiental. Cuando llegue al final de su vida útil, debe desecharse en un punto de reciclaje destinado a productos eléctricos y electrónicos.

Cómo utilizar el producto

I. Conexión del DELTA Pro

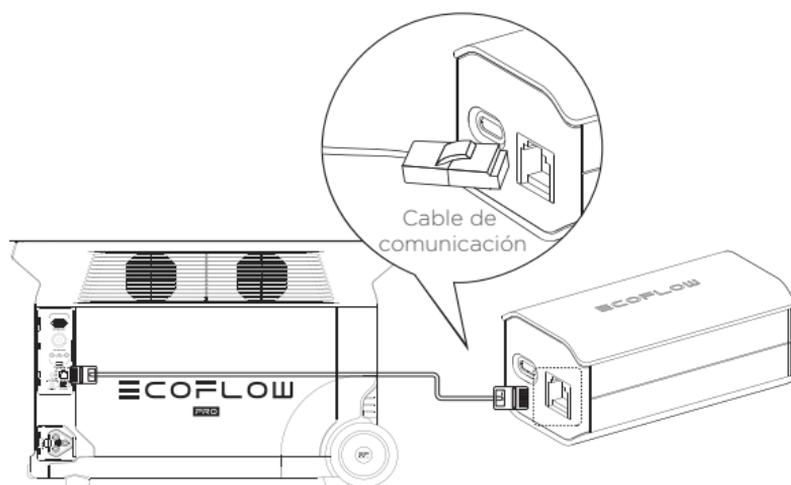

* Puerto de comunicación: solo para uso con DELTA Pro

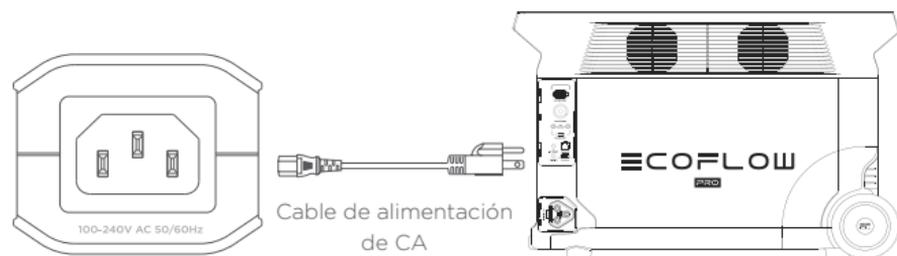

* Se recomienda utilizar el cable de alimentación del DELTA Pro. Se suministra de serie o puede adquirirse por separado.

Cómo utilizar el producto

II. Conexión del DELTA Max

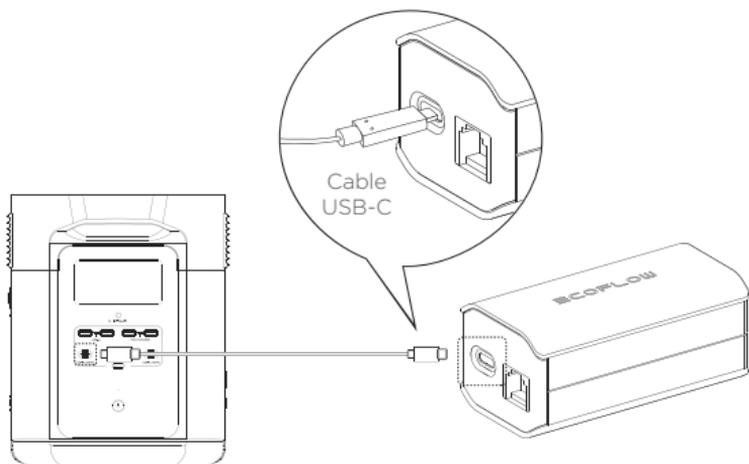

(conéctelo al puerto USB-C izquierdo; no utilice el puerto USB-C derecho)

* Puerto USB-C: solo para uso con DELTA Max

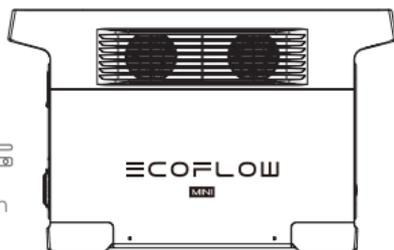
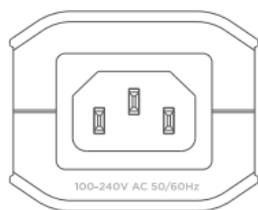

* Se recomienda utilizar el cable de alimentación del DELTA Max. Se suministra de serie o puede adquirirse por separado.

Regístrate ahora para obtener ¡24 MESES DE GARANTÍA!



<https://warranty.ecoflow.com/>



¿Por qué registrarse?

- Sirve como prueba para una reclamación de pérdida de seguro.
- Obtén asistencia inmediata para los productos EcoFlow.
- Obtén acceso instantáneo a las noticias relativas al lanzamiento de productos.

Contacta con nosotros

+1 (800)-368-8604, de lunes a viernes de 9:00 a 21:00 h (EST)

<https://ecoflow.com/pages/contact-us>



NA/LA/APAC/MEA: support@ecoflow.com,

EU: support.eu@ecoflow.com, **AU:** support.au@ecoflow.com

Redes sociales:



@ecoflowtech

Productintroductie

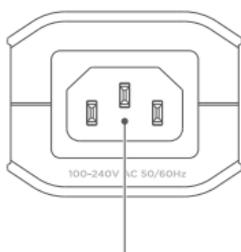

AC-invoerpoort

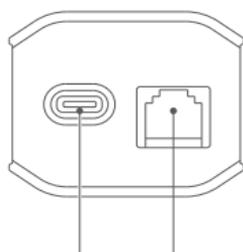

USB-C-uitgangspoort Communicatiepoort

Productspecificaties

AC-ingangsspanning:	100-240 V-50/60 Hz
USB-C-voedingsspanning:	5 V \equiv 300 mA Max
Voedingsspanning netwerkpoort:	12 V \equiv 300 mA Max
Bedrijfstemperatuur:	-10-45°C (14-113°F)

Gebruikersinstructies

1. Dit product is alleen geschikt voor gebruik met de EcoFlow DELTA Pro en DELTA Max.
2. Om de veiligheid tijdens het opladen van een elektrisch voertuig te waarborgen, wordt de AC-oplaadfunctie van de machine uitgeschakeld nadat de aardingsadapter voor het draagbare laadstation en de machine zijn geïdentificeerd.
3. De USB-C-naar-USB-C-kabel is een speciale kabel en is niet compatibel met andere universele Type C-kabels. Deze kabel moet goed worden bewaard. Vervangende producten kunnen indien nodig worden aangeschaft via de officiële verkoopkanalen van EcoFlow.
4. Zorg ervoor dat dit product wordt afgevoerd in overeenstemming met de richtlijnen voor milieubescherming. Wanneer het einde van de levensduur is bereikt, moet het product worden ingeleverd op een speciaal recyclingpunt voor elektronische en elektrische producten.

Hoe te gebruiken

I. De DELTA Pro aansluiten

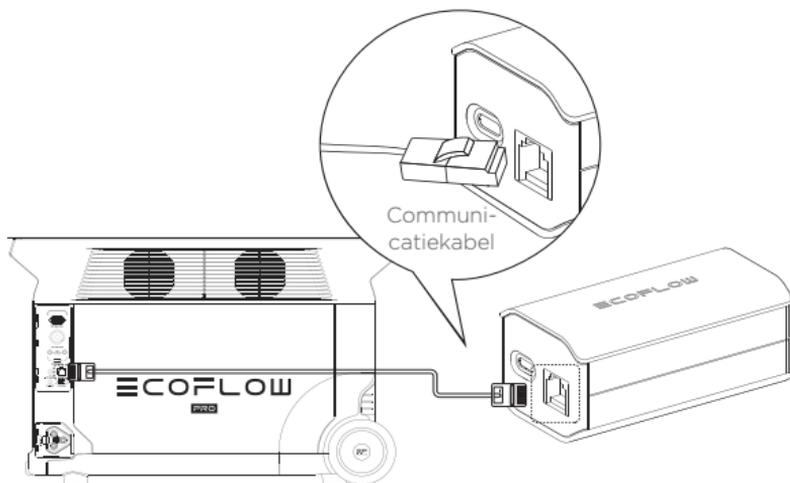

* Communicatiepoort: Alleen voor gebruik met DELTA Pro

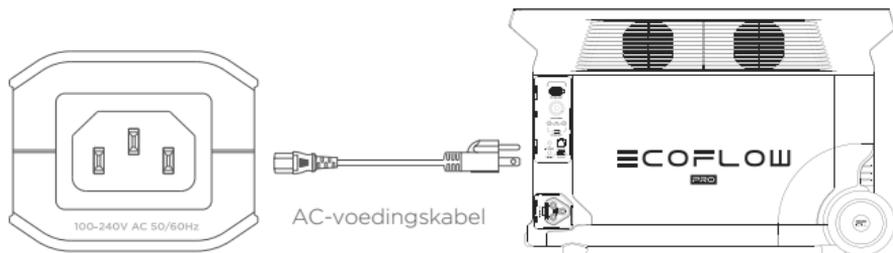

* Wij raden u aan de DELTA Pro-voedingskabel te gebruiken. Deze wordt standaard meegeleverd of kan afzonderlijk worden aangeschaft.

Hoe te gebruiken

II. De DELTA Max aansluiten

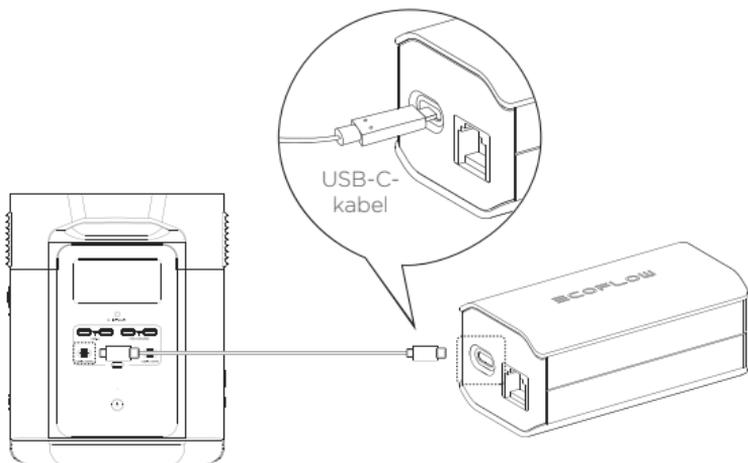

(Sluit aan op de linker USB-C-poort;
gebruik de rechter USB-C-poort niet)

* USB-C-poort: Alleen voor gebruik met DELTA Max

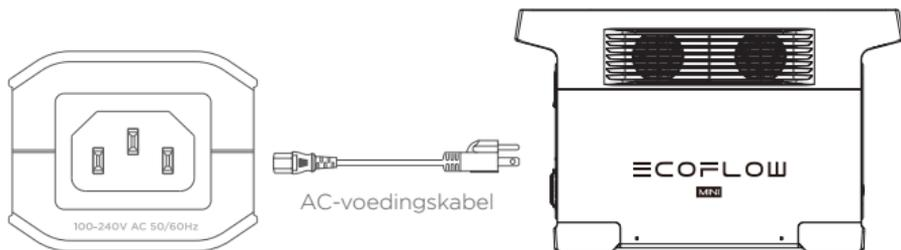

* Wij raden u aan de DELTA Max-voedingskabel te gebruiken.
Deze wordt standaard meegeleverd of kan afzonderlijk worden aangeschaft.

Nu registreren om te ontvangen 24 MAANDEN GARANTIE!



<https://warranty.ecoflow.com/>



Waarom registreren?

- Dient als bewijs voor een schadeclaim bij de verzekering
- Ontvang direct EcoFlow-productondersteuning
- Ontvang direct nieuws over nieuw uitgebrachte producten

Neem contact met ons op

 +1 (800)-368-8604 ma-vr 9 am-9 pm (EST)

 <https://ecoflow.com/pages/contact-us>



NA/LA/APAC/MEA: support@ecoflow.com,

EU: support.eu@ecoflow.com, AU: support.au@ecoflow.com

Sociale media:



[@ecoflowtech](https://www.ecoflowtech.com)

Знакомство с продукцией

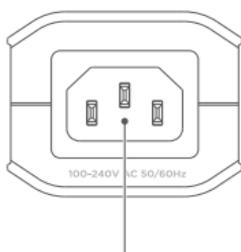

Входной порт переменного тока

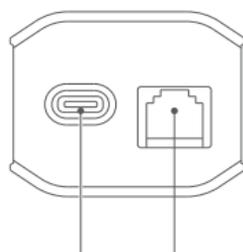

USB-C выходной порт

Коммуникационный порт

Характеристики продукта

Входное напряжение переменного тока:	100–240 V–50/60 Hz
Напряжение питания USB-C:	5 V \equiv 300 mA Max
Напряжение питания сетевого порта:	12 V \equiv 300 mA Max
Рабочая Температура:	-10~45°C (14~113°F)

Инструкции пользователя

1. Этот продукт подходит только для использования с EcoFlow DELTA Pro и DELTA Max.
2. Для обеспечения безопасности при зарядке электромобиля функция зарядки от сети переменного тока машины будет отключена после успешной идентификации заземляющего адаптера портативной электростанции и машины.
3. Кабель USB-C — USB-C-это специальный кабель, который несовместим с другими универсальными кабелями типа C. Этот кабель необходимо хранить надлежащим образом. При необходимости замену можно приобрести в официальных дилеров EcoFlow.
4. Пожалуйста, убедитесь, что этот продукт утилизирован в соответствии с правилами защиты окружающей среды. По истечении срока службы его необходимо утилизировать в специально отведенном для этого пункте утилизации электронных и электрических изделий.

Как использовать

I. Подключение к DELTA Pro

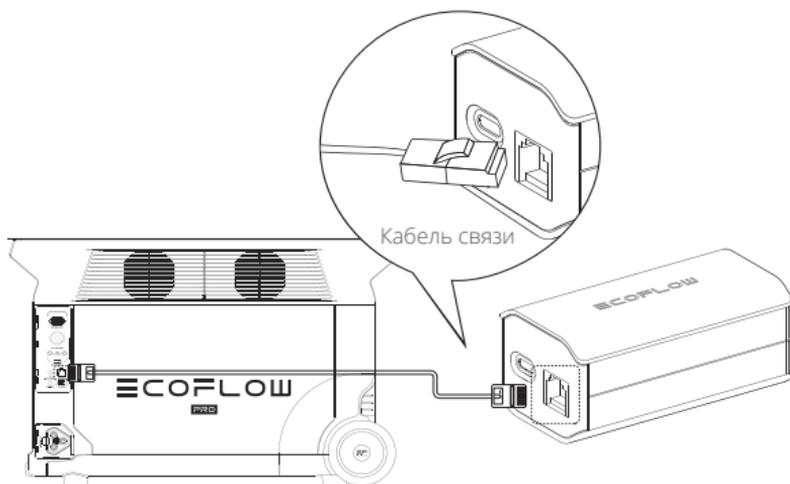

* Коммуникационный порт: Только для использования с DELTA Pro



* Мы рекомендуем использовать кабель питания DELTA Pro. Он входит в стандартную комплектацию или может быть приобретен отдельно.

Как использовать

II. Подключение к DELTA Max

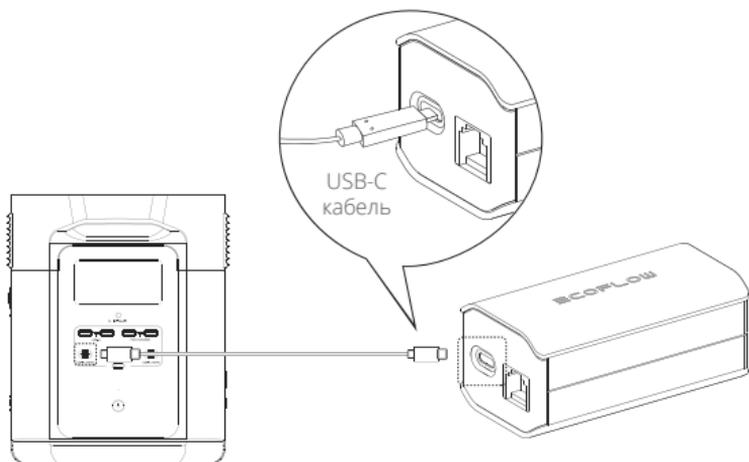

(Пожалуйста, подключите к левому порту USB-C; не используйте правый порт USB-C)

* Порт USB-C :Только для использования с DELTA Max



* Мы рекомендуем использовать кабель питания DELTA Max. Он входит в стандартную комплектацию или может быть приобретен отдельно.

Зарегистрируйтесь сейчас, чтобы получить **24-МЕСЯЧНАЯ ГАРАНТИЯ!**



<https://warranty.ecoflow.com/>



Зачем регистрироваться?

- Служит доказательством страхового возмещения
- Получите мгновенную поддержку продукта EcoFlow
- Получите мгновенный доступ к новостям о выпуске продукта

Свяжитесь с нами

 +1 (800)-368-8604 Пн-Пт 9 am-9 pm (EST)

 <https://ecoflow.com/pages/contact-us>



NA/LA/APAC/MEA: support@ecoflow.com,
EU: support.eu@ecoflow.com, **AU:** support.au@ecoflow.com

Социальные сети:



[@ecoflowtech](https://twitter.com/ecoflowtech)

產品簡介

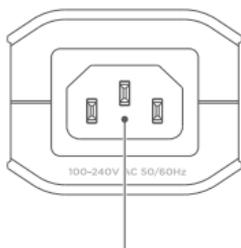

交流輸入端口

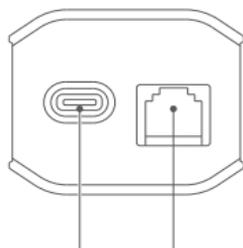

USB-C 輸出端口 通訊端口

產品規格

交流輸入電壓：	100-240V~ 50/60Hz
USB-C 供電電壓：	最大 5V \equiv 300mA
網絡端口供電電壓：	最大 12V \equiv 300mA
操作溫度：	-10 ~ 45°C(14~113°F)

用戶說明

1. 本產品僅適用於 EcoFlow DELTA Pro 和 DELTA Max。
2. 為確保電動汽車充電安全，在成功識別便攜式電站接地適配器和機器後，機器的交流充電功能將被禁用。
3. USB-C 轉 USB-C 連接線是定制連接線，與其他通用 Type C 連接線不兼容。請務必小心存放此連接線。如需更換，可從 EcoFlow 官方銷售渠道購買。
4. 請確保按照環保指南丟棄本產品。當其達到使用壽命時，必須將其丟棄至指定的電子電氣產品回收點。

如何使用

I. 連接 DELTA Pro

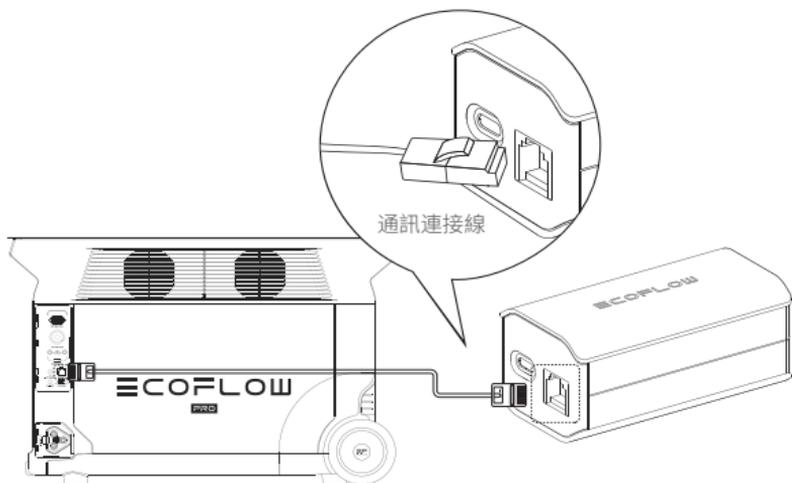

* 通訊端口：僅與 DELTA Pro 一同使用

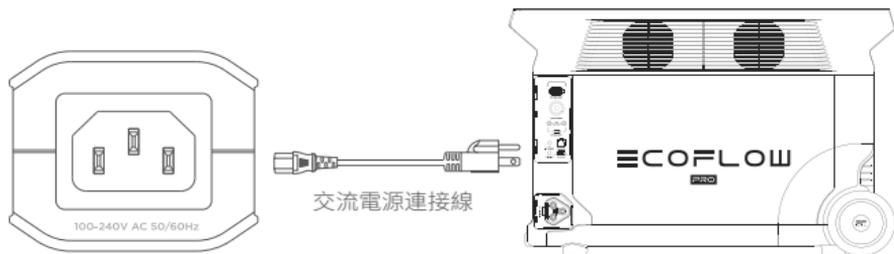

* 我們推薦使用 DELTA Pro 電源連接線。
它作為標準配件提供，也可以單獨購買。

如何使用

II. 連接 DELTA Max

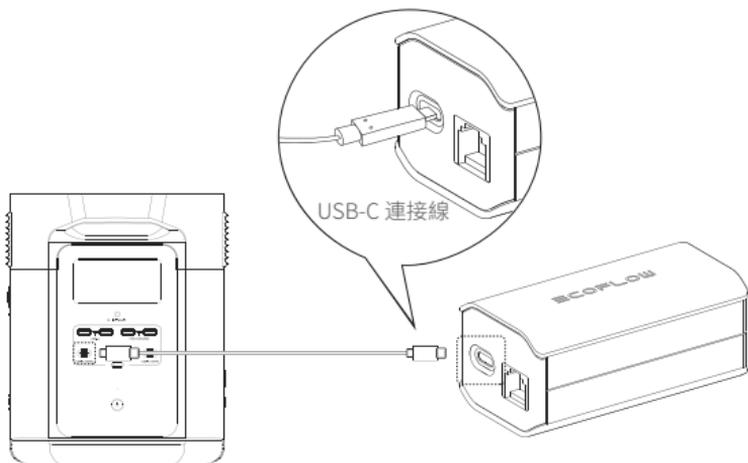

(請插入左側 USB-C 端口；
請勿使用右側 USB-C 端口)

* USB-C 端口：僅與 DELTA Max 一同使用

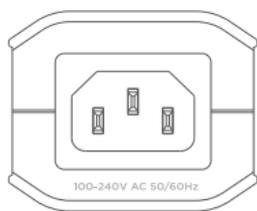

交流電源連接線

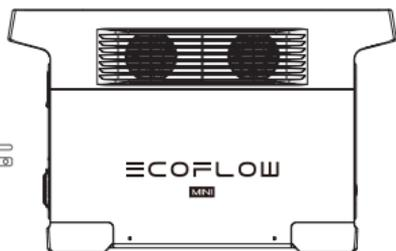

* 我們推薦使用 DELTA Max 電源連接線。
它作為標準配件提供，也可以單獨購買。

≡ COFLOW